



New

**Internal
Machining**

Carbide Shank Boring Bars

Features

- Excellent cutting performance in wide range of boring size even at vibration cutting condition.
- Applied for various workpiece such as steel, stainless steel, cast iron, etc.
- Assures longer tool life and excellent surface finish.









Carbide Shank Boring Bars

Code System | Application example

Code System



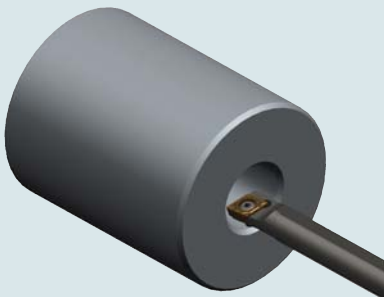

C	12	M	-
Shank type	Shank diameter	Shank length (mm)	
S : Steel shank A : Steel shank with oil hole C : Carbide shank E : Carbide shank with oil hole	ISO : mm AISI : inch	F : 80 R : 200 G : 90 S : 250 H : 100 T : 300 J : 110 U : 350 K : 125 V : 400 M : 150 W : 450 Q : 180 T : 500	

S	C	L	C	R	-	06
Clamping system	Insert shape	Lead angle	Relief angle of Insert	Hand of tool		Length of cutting edge
S : Screw on P : Lever lock C : Clamp on M : Multi lock W : Wedge clamp D : Double clamp	C : 80° Rhombic D : 55° Rhombic S : 90° Square T : 60° Triangular V : 35° Rhombic W : 80° Trigon	F : 90° K : 75° L : 95° Q : 108° U : 93°	B : 5° Positive C : 7° Positive N : 0° P : 11° Positive	R : Right L : Left		80° Rhombic  55° Rhombic  90° Square  60° Triangular  35° Rhombic  80° Trigon 

Application example

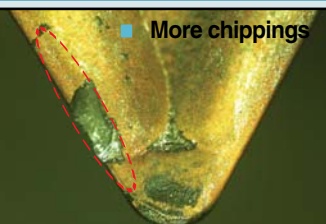

- Cutting conditions
 - Insert : TCMT110204-HMP
 - Boring bar : C12M-STFCR-11
 - Workpiece : SCM440
 - Cutting speed : 200 m/min
 - Depth of cut : 0.4 mm
 - Feed : 0.15 mm/rev

	Steel boring bar			Carbide boring bar		
5D Machining test (After 40passes)	 ■ More chippings			 ■ Long and stable tool life		
Surface Roughness (5D machining)						
	Rmax	Rz	Ra	Rmax	Rz	Ra
	4.67	3.68	0.62	3.07	2.76	0.53

Carbide Shank Boring Bars

Features

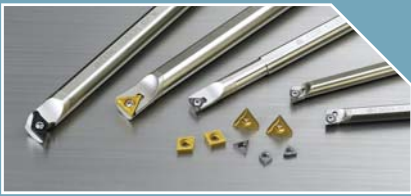

Features

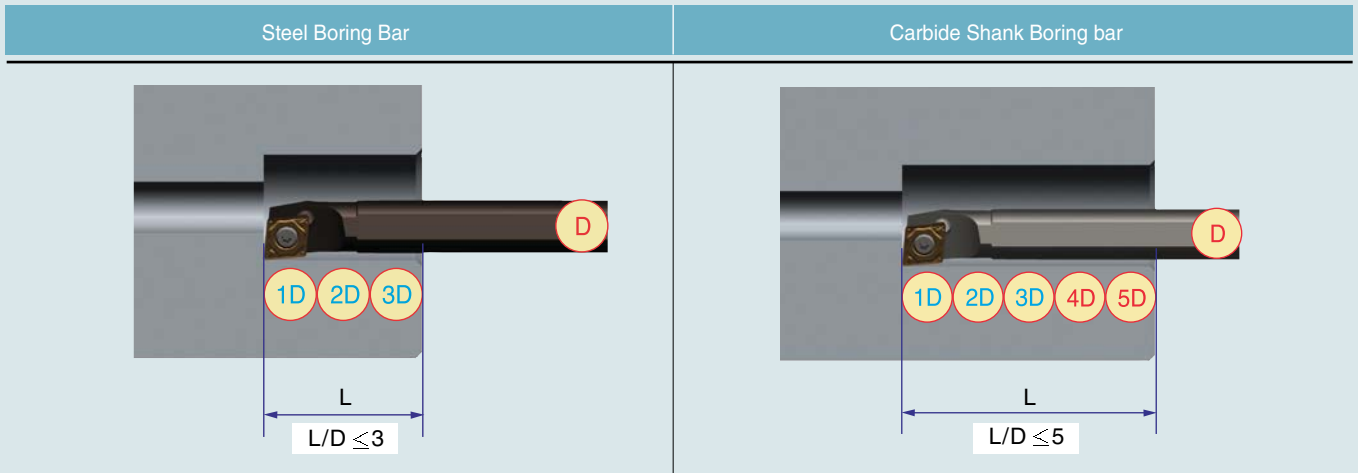

. Excellent chip control

. Special brazing technique assures quality security

. Improved durability by special surface treatment

. Much better rigidity than steel bars

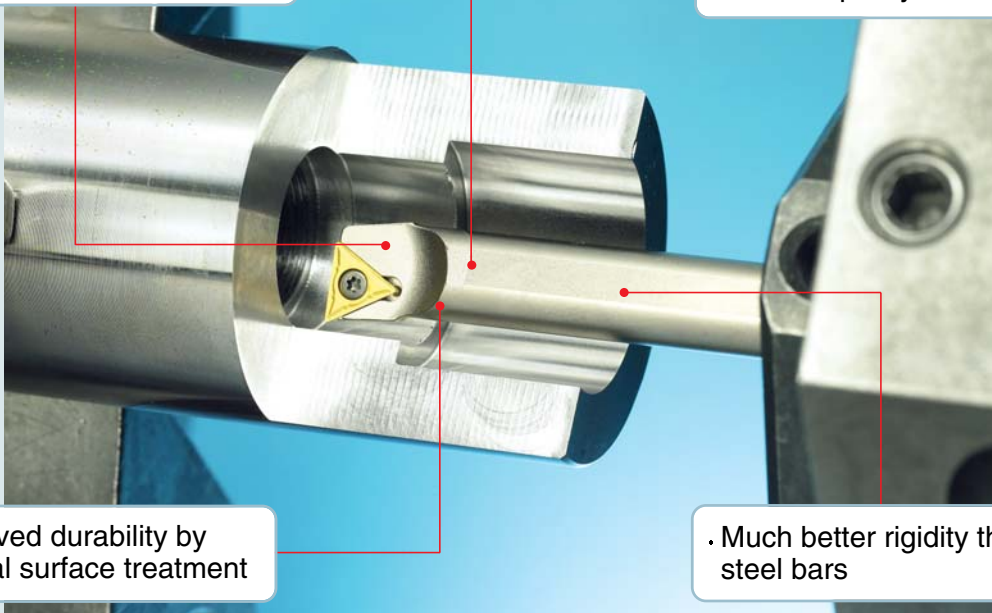

Carbide Shank Boring Bars

SCLCR/L

SCLCR/L

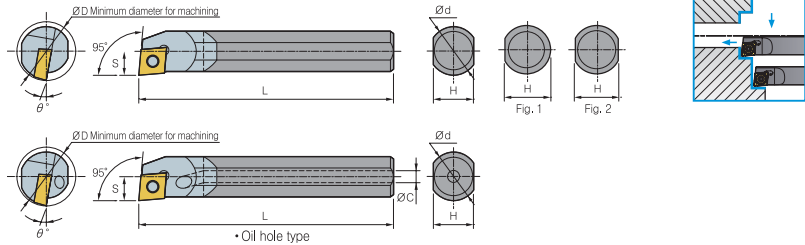

Designation	Stock		øD	ød	H	L	S	θ°	Parts Insert	Screw	Wrench	Fig.
	R	L										
C04G-SCLCR/L-03	●	○	5	4	3.8	90	2.5	-15°	CC□T0301□□	FTNA01633	TW06P	1
C05H-SCLCR/L-03	●	○	6	5	4.4	100	3	-15°	CC□T0301□□	FTNA01633	TW06P	1
C06H-SCLCR/L-04	●	○	7	6	5.4	100	3.5	-15°	CC□T0401□□	FTNA0238	TW06P	1
C07K-SCLCR/L-04	●	○	8	7	6.4	125	4	-12°	CC□T0401□□	FTNA0238	TW06P	1
C08K-SCLCR/L-06	●	○	10	8	7	125	5	-12°	CC□T0602□□	FTKA02555	TW07P	2
C10K-SCLCR/L-06	●	○	12	10	9	125	6	-12°	CC□T0602□□	FTKA02565	TW07P	2
C10M-SCLCR/L-06	●	○	12	10	9	150	6	-12°	CC□T0602□□	FTKA02565	TW07P	2
C12M-SCLCR/L-06	●	○	14	12	11	150	7	-12°	CC□T0602□□	FTKA02565	TW07P	2
C12Q-SCLCR/L-06	●	○	14	12	11	180	7	-12°	CC□T0602□□	FTKA02565	TW07P	2
C12M-SCLCR/L-09	●	○	15	12	11	150	8	-12°	CC□T09T3□□	FTGA03508	TW15P	2
C12Q-SCLCR/L-09	●	○	15	12	11	180	8	-12°	CC□T09T3□□	FTGA03508	TW15P	2
C16R-SCLCR/L-09	●	○	20	16	15	250	10	-12°	CC□T09T3□□	FTGA03508	TW15P	2
C16S-SCLCR/L-09	●	○	20	16	15	250	10	-12°	CC□T09T3□□	FTGA03508	TW15P	2
C20R-SCLCR/L-09	●	○	25	20	18	200	13	-8°	CC□T09T3□□	FTGA03508	TW15P	2
C20S-SCLCR/L-09	●	○	25	20	18	250	13	-8°	CC□T09T3□□	FTGA03508	TW15P	2
C25T-SCLCR/L-12	●	○	32	25	23	300	17	-6°	CC□T1204□□	FTGA0411F	TW15P	2
E06H-SCLCR/L-04	●	○	7	6	5.4	100	3.5	-1°	CC□T0401□□	FTNA0238	TW06P	1
E07K-SCLCR/L-04	●	○	8	7	6.4	125	4	-1°	CC□T0401□□	FTNA0238	TW06P	1
E08K-SCLCR/L-06	●	○	10	8	7	125	5	-1°	CC□T0602□□	FTKA02555	TW07P	2
E10K-SCLCR/L-06	●	○	12	10	9	125	6	-12°	CC□T0602□□	FTKA02565	TW07P	2
E10M-SCLCR/L-06	●	○	12	10	9	150	6	-12°	CC□T0602□□	FTKA02565	TW07P	2
E12M-SCLCR/L-06	●	○	14	12	11	150	7	-12°	CC□T0602□□	FTKA02565	TW07P	2
E12Q-SCLCR/L-06	●	○	14	12	11	180	7	-12°	CC□T0602□□	FTKA02565	TW07P	2
E12M-SCLCR/L-09	●	○	15	12	11	150	8	-12°	CC□T09T3□□	FTGA03508	TW15P	2
E12Q-SCLCR/L-09	●	○	15	12	11	180	8	-12°	CC□T09T3□□	FTGA03508	TW15P	2
E16R-SCLCR/L-09	●	○	20	16	15	250	10	-12°	CC□T09T3□□	FTGA03508	TW15P	2
E16S-SCLCR/L-09	●	○	20	16	15	250	10	-12°	CC□T09T3□□	FTGA03508	TW15P	2
E20R-SCLCR/L-09	●	○	25	20	18	200	13	-8°	CC□T09T3□□	FTGA03508	TW15P	2
E20S-SCLCR/L-09	●	○	25	20	18	250	13	-8°	CC□T09T3□□	FTGA03508	TW15P	2
E25T-SCLCR/L-12	●	○	32	25	23	300	17	-6°	CC□T1204□□	FTGA0411F	TW15P	2

●: Stock item, ○: Under preparing for stock

Carbide Shank Boring Bars

SCLPR/L



SCLPR/L

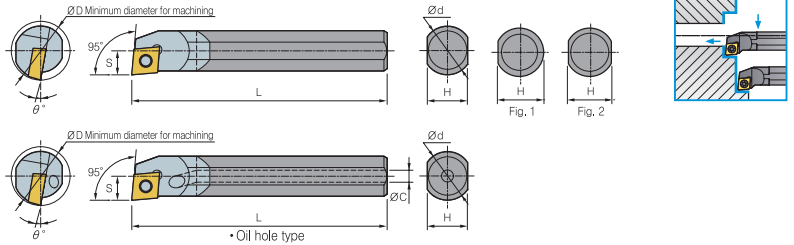

Designation	Stock		ØD	ød	H	L	S	θ°	Parts Insert	Screw	Wrench	Fig.
	R	L										
C10K-SCLPR/L-08	●	○	12	10	9	125	6	-5°	CP □ T0802 □ □	FTNA0305	TW09P	2
C10M-SCLPR/L-08	●	○	12	10	9	150	6	-5°	CP □ T0802 □ □	FTNA0305	TW09P	2
C12M-SCLPR/L-08	●	○	15	12	11	150	7.5	-2°	CP □ T0802 □ □	FTNA0307	TW09P	2
C12Q-SCLPR/L-08	●	○	15	12	11	180	7.5	-2°	CP □ T0802 □ □	FTNA0307	TW09P	2
C12M-SCLPR/L-09	●	○	15	12	11	150	8	-2°	CP □ T0903 □ □	FTNA0408	TW15P	2
C12Q-SCLPR/L-09	●	○	15	12	11	180	8	-2°	CP □ T0903 □ □	FTNA0408	TW15P	2
C16R-SCLPR/L-09	●	○	20	16	15	200	10	-2°	CP □ T0903 □ □	FTNA0408	TW15P	2
C16S-SCLPR/L-09	●	○	20	16	15	250	10	-2°	CP □ T0903 □ □	FTNA0408	TW15P	2
C20R-SCLPR/L-09	●	○	25	20	18	200	13	-2°	CP □ T0903 □ □	FTNA0408	TW15P	2
C20S-SCLPR/L-09	●	○	25	20	18	250	13	-2°	CP □ T0903 □ □	FTNA0408	TW15P	2
E10K-SCLPR/L-08	●	○	12	10	9	125	6	-5°	CP □ T0802 □ □	FTNA0305	TW09P	2
E10M-SCLPR/L-08	●	○	12	10	9	150	6	-5°	CP □ T0802 □ □	FTNA0305	TW09P	2
E12M-SCLPR/L-08	●	○	15	12	11	150	7.5	-2°	CP □ T0802 □ □	FTNA0307	TW09P	2
E12Q-SCLPR/L-08	●	○	15	12	11	180	7.5	-2°	CP □ T0802 □ □	FTNA0307	TW09P	2
E12M-SCLPR/L-09	●	○	15	12	11	150	8	-2°	CP □ T0903 □ □	FTNA0408	TW15P	2
E12Q-SCLPR/L-09	●	○	15	12	11	180	8	-2°	CP □ T0903 □ □	FTNA0408	TW15P	2
E16R-SCLPR/L-09	●	○	20	16	15	200	10	-2°	CP □ T0903 □ □	FTNA0408	TW15P	2
E16S-SCLPR/L-09	●	○	20	16	15	250	10	-2°	CP □ T0903 □ □	FTNA0408	TW15P	2
E20R-SCLPR/L-09	●	○	25	20	18	200	13	-2°	CP □ T0903 □ □	FTNA0408	TW15P	2
E20S-SCLPR/L-09	●	○	25	20	18	250	13	-2°	CP □ T0903 □ □	FTNA0408	TW15P	2

●: Stock item, ○: Under preparing for stock

Carbide Shank Boring Bars

SDQCR/L

SDQCR/L

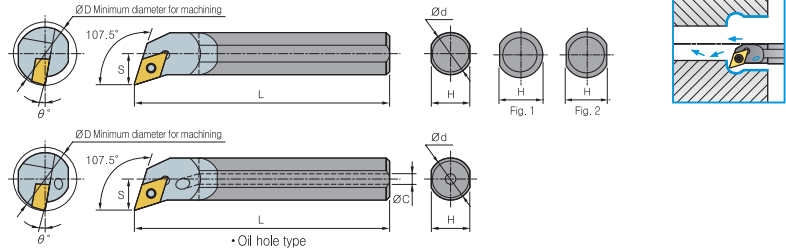

Desingation	Stock		øD	ød	H	L	S	θ°	Parts Insert	Screw	Wrench	Fig.
	R	L										
C08K-SDQCR/L-07	●	○	10	8	7	125	6	-15°	DC □ T0702 □ □	FTKA02555	TW07P	2
C10K-SDQCR/L-07	●	○	13	10	9	125	7	-15°	DC □ T0702 □ □	FTKA02555	TW07P	2
C12M-SDQCR/L-07	●	○	16	12	11	150	9	-10°	DC □ T0702 □ □	FTKA02565	TW07P	2
C16R-SDQCR/L-07	●	○	20	16	15	200	11	-6°	DC □ T0702 □ □	FTKA02565	TW07P	2
C16R-SDQCR/L-11	●	○	20	16	15	200	11	-6°	DC □ T11T3 □ □	FTGA03508	TW15P	2
C20R-SDQCR/L-11	●	○	25	20	18	200	13	-6°	DC □ T11T3 □ □	FTGA03508	TW15P	2
C20S-SDQCR/L-11	●	○	25	20	18	250	13	-6°	DC □ T11T3 □ □	FTGA03508	TW15P	2
E08K-SDQCR/L-07	●	○	10	8	7	125	6	-1°	DC □ T0702 □ □	FTKA02555	TW07P	2
E10K-SDQCR/L-07	●	○	13	10	9	125	7	-1°	DC □ T0702 □ □	FTKA02555	TW07P	2
E12M-SDQCR/L-07	●	○	16	12	11	150	9	-10°	DC □ T0702 □ □	FTKA02565	TW07P	2
E16R-SDQCR/L-07	●	○	20	16	15	200	11	-6°	DC □ T0702 □ □	FTKA02565	TW07P	2
E16R-SDQCR/L-11	●	○	20	16	15	200	11	-6°	DC □ T11T3 □ □	FTGA03508	TW15P	2
E20R-SDQCR/L-11	●	○	25	20	18	200	13	-6°	DC □ T11T3 □ □	FTGA03508	TW15P	2
E20S-SDQCR/L-11	●	○	25	20	18	250	13	-6°	DC □ T11T3 □ □	FTGA03508	TW15P	2

●: Stock item, ○: Under preparing for stock

Carbide Shank Boring Bars

SDUCR/L



SDUCR/L

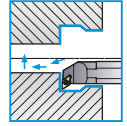
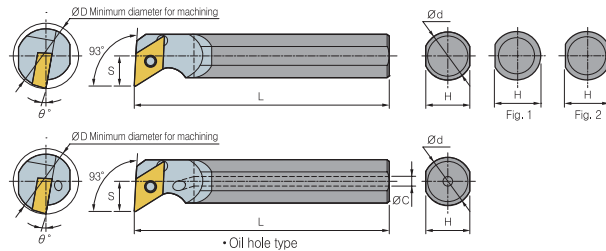

Desingation	Stock		ØD	Ød	H	L	S	θ°	Parts Insert	Screw	Wrench	Fig.
	R	L										
C10K-SDUCR/L-07	●	○	13	10	9	125	7	-15°	DC□T0702□□	FTKA02555	TW07P	2
C10M-SDUCR/L-07	●	○	13	10	9	150	7	-15°	DC□T0702□□	FTKA02555	TW07P	2
C12M-SDUCR/L-07	●	○	16	12	11	150	9	-10°	DC□T0702□□	FTKA02565	TW07P	2
C12Q-SDUCR/L-07	●	○	16	12	11	180	9	-10°	DC□T0702□□	FTKA02565	TW07P	2
C16R-SDUCR/L-07	●	○	20	16	15	200	11	-6°	DC□T0702□□	FTKA02565	TW07P	2
C16S-SDUCR/L-07	●	○	20	16	15	250	11	-6°	DC□T0702□□	FTKA02565	TW07P	2
C16R-SDUCR/L-11	●	○	20	16	15	200	11	-6°	DC□T11T3□□	FTGA03508	TW15P	2
C16S-SDUCR/L-11	●	○	20	16	15	250	11	-6°	DC□T11T3□□	FTGA03508	TW15P	2
C20R-SDUCR/L-11	●	○	25	20	18	200	13	-6°	DC□T11T3□□	FTGA03508	TW15P	2
C20S-SDUCR/L-11	●	○	25	20	18	250	13	-6°	DC□T11T3□□	FTGA03508	TW15P	2
C25T-SDUCR/L-11	●	○	32	25	23	300	17	-6°	DC□T11T3□□	FTGA03510	TW15P	2
E10K-SDUCR/L-07	●	○	13	10	9	125	7	-15°	DC□T0703□□	FTKA02555	TW07P	2
E10M-SDUCR/L-07	●	○	13	10	9	150	7	-15°	DC□T0702□□	FTKA02555	TW07P	2
E12M-SDUCR/L-07	●	○	16	12	11	150	9	-10°	DC□T0702□□	FTKA02565	TW07P	2
E12Q-SDUCR/L-07	●	○	16	12	11	180	9	-10°	DC□T0702□□	FTKA02565	TW07P	2
E16R-SDUCR/L-07	●	○	20	16	15	200	11	-6°	DC□T0702□□	FTKA02565	TW07P	2
E16S-SDUCR/L-07	●	○	20	16	15	250	11	-6°	DC□T0702□□	FTKA02565	TW07P	2
E16R-SDUCR/L-11	●	○	20	16	15	200	11	-6°	DC□T11T3□□	FTGA03508	TW15P	2
E16S-SDUCR/L-11	●	○	20	16	15	250	11	-6°	DC□T11T3□□	FTGA03508	TW15P	2
E20R-SDUCR/L-11	●	○	25	20	18	200	13	-6°	DC□T11T3□□	FTGA03508	TW15P	2
E20S-SDUCR/L-11	●	○	25	20	18	250	13	-6°	DC□T11T3□□	FTGA03508	TW15P	2
E25T-SDUCR/L-11	●	○	32	25	23	300	17	-6°	DC□T11T3□□	FTKA02555	TW15P	2

●: Stock item, ○: Under preparing for stock

Carbide Shank Boring Bars

STFCR/L

STFCR/L

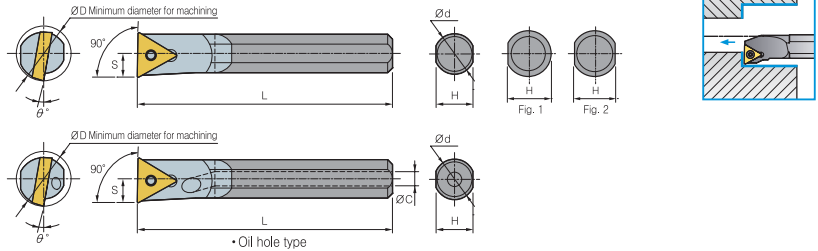

Desingation	Stock		θD	θd	H	L	S	θ°	Parts		Screw	Wrench	Fig.
	R	L							Insert				
C08K-STFCR/L-09	●	○	10	8	7	125	5	-10°	TC □ T0902 □ □		FTKA02206	TW06P	2
C10K-STFCR/L-09	●	○	12	10	9	125	6	-10°	TC □ T0902 □ □		FTKA02206	TW06P	2
C10K-STFCR/L-11	●	○	12	10	9	125	6	-10°	TC □ T1102 □ □		FTKA02565	TW07P	2
C12M-STFCR/L-11	●	○	15	12	11	150	8	-10°	TC □ T1102 □ □		FTKA02565	TW07P	2
C16R-STFCR/L-11	●	○	20	16	15	200	10	-10°	TC □ T1102 □ □		FTKA02565	TW07P	2
C20R-STFCR/L-11	●	○	25	20	18	200	13	-6°	TC □ T1102 □ □		FTKA02565	TW07P	2
C20S-STFCR/L-11	●	○	25	20	18	250	13	-6°	TC □ T1102 □ □		FTKA02565	TW07P	2
C20R-STFCR/L-16	●	○	25	20	18	200	13	-6°	TC □ T16T3 □ □		FTGA03510	TW15P	2
C20S-STFCR/L-16	●	○	25	20	18	250	13	-6°	TC □ T16T3 □ □		FTGA03510	TW15P	2
E08K-STFCR/L-09	●	○	10	8	7	125	5	-10°	TC □ T0902 □ □		FTKA02206	TW06P	2
E10K-STFCR/L-09	●	○	12	10	9	125	6	-10°	TC □ T0902 □ □		FTKA02206	TW06P	2
E10K-STFCR/L-11	●	○	12	10	9	125	6	-10°	TC □ T1102 □ □		FTKA02565	TW07P	2
E12M-STFCR/L-11	●	○	15	12	11	150	8	-10°	TC □ T1102 □ □		FTKA02565	TW07P	2
E16R-STFCR/L-11	●	○	20	16	15	200	10	-10°	TC □ T1102 □ □		FTKA02565	TW07P	2
E20R-STFCR/L-11	●	○	25	20	18	200	13	-6°	TC □ T1102 □ □		FTKA02565	TW07P	2
E20S-STFCR/L-11	●	○	25	20	18	250	13	-6°	TC □ T1102 □ □		FTKA02565	TW07P	2
E20R-STFCR/L-16	●	○	25	20	18	200	13	-6°	TC □ T16T3 □ □		FTGA03510	TW15P	2
E20S-STFCR/L-16	●	○	25	20	18	250	13	-6°	TC □ T16T3 □ □		FTGA03510	TW15P	2

●: Stock item, ○: Under preparing for stock

Carbide Shank Boring Bars

STUPR/L

STUPR/L

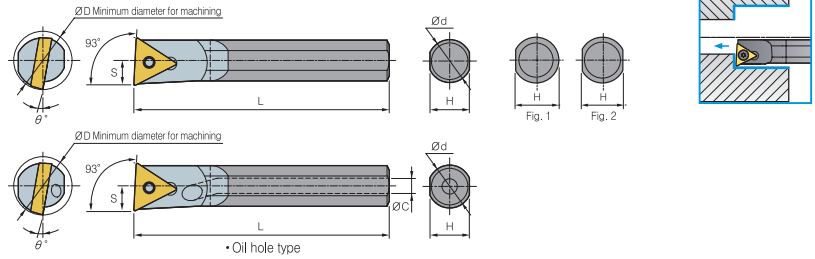

Desingation	Stock		ØD	ød	H	L	S	θ°	Parts Insert	Screw	Wrench	Fig.
	R	L										
C08K-STUPR/L-08	●	○	10	8	7	125	5	-10°	TP □T0802 □□	FTNA02205	TW06P	2
C10K-STUPR/L-11	●	○	12	10	9	125	6	-10°	TP □T1103 □□	FTNA0305	TW09P	2
C10M-STUPR/L-11	●	○	12	10	9	150	6	-10°	TP □T1103 □□	FTNA0305	TW09P	2
C12M-STUPR/L-11	●	○	15	12	11	150	8	-10°	TP □T1103 □□	FTNA0307	TW09P	2
C12Q-STUPR/L-11	●	○	15	12	11	180	8	-10°	TP □T1103 □□	FTNA0307	TW09P	2
C16R-STUPR/L-11	●	○	20	16	15	200	10	-6°	TP □T1103 □□	FTNA0307	TW09P	2
C16S-STUPR/L-11	●	○	20	16	15	250	10	-6°	TP □T1103 □□	FTNA0307	TW09P	2
C20R-STUPR/L-11	●	○	25	20	18	200	13	-6°	TP □T1103 □□	FTNA0307	TW09P	2
C20S-STUPR/L-11	●	○	25	20	18	250	13	-6°	TP □T1103 □□	FTNA0307	TW09P	2
C20R-STUPR/L-16	●	○	25	20	18	200	13	-6°	TP □T1604 □□	FTNA0408	TW15P	2
C20S-STUPR/L-16	●	○	25	20	18	250	13	-6°	TP □T1604 □□	FTNA0408	TW15P	2
C25T-STUPR/L-16	●	○	32	25	23	300	17	-6°	TP □T1604 □□	FTNA0408	TW15P	2
E08K-STUPR/L-08	●	○	10	8	7	125	5	-10°	TP □T0803 □□	FTNA02205	TW06P	2
E10K-STUPR/L-11	●	○	12	10	9	125	6	-10°	TP □T1103 □□	FTNA0305	TW09P	2
E10M-STUPR/L-11	●	○	12	10	9	150	6	-10°	TP □T1103 □□	FTNA0305	TW09P	2
E12M-STUPR/L-11	●	○	15	12	11	150	8	-10°	TP □T1103 □□	FTNA0307	TW09P	2
E12Q-STUPR/L-11	●	○	15	12	11	180	8	-10°	TP □T1103 □□	FTNA0307	TW09P	2
E16R-STUPR/L-11	●	○	20	16	15	200	10	-6°	TP □T1103 □□	FTNA0307	TW09P	2
E16S-STUPR/L-11	●	○	20	16	15	250	10	-6°	TP □T1103 □□	FTNA0307	TW09P	2
E20R-STUPR/L-11	●	○	25	20	18	200	13	-6°	TP □T1103 □□	FTNA0307	TW09P	2
E20S-STUPR/L-11	●	○	25	20	18	250	13	-6°	TP □T1103 □□	FTNA0307	TW09P	2
E20R-STUPR/L-16	●	○	25	20	18	200	13	-6°	TP □T1604 □□	FTNA0408	TW15P	2
E20S-STUPR/L-16	●	○	25	20	18	250	13	-6°	TP □T1604 □□	FTNA0408	TW15P	2
E25T-STUPR/L-16	●	○	32	25	23	300	17	-6°	TP □T1604 □□	FTNA0408	TW15P	2

●: Stock item, ○: Under preparing for stock

Carbide Shank Boring Bars

STUBR/L | SWUBR/L

STUBR/L

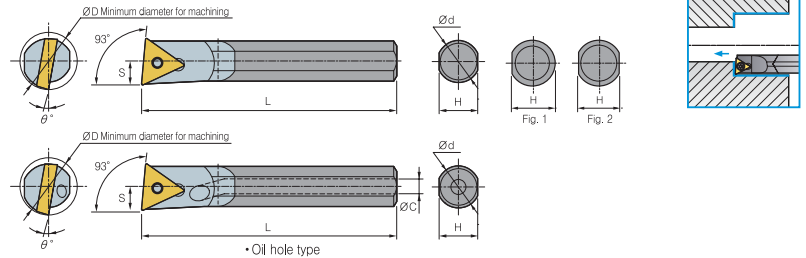

Desingation	Stock		ØD	Ød	H	L	S	θ°	Parts Insert	Screw	Wrench	Fig.
	R	L										
C08K-STUBR/L-06	●	○	10	8	7	125	5	-10°	TB □ T0601 □ □	FTNA0204	TW06P	2
C10K-STUBR/L-06	●	○	12	10	9	125	6	-10°	TB □ T0601 □ □	FTNA0204	TW06P	2
E08K-STUBR/L-06	●	○	10	8	7	125	5	-10°	TB □ T0601 □ □	FTNA0204	TW06P	2
E10K-STUBR/L-06	●	○	12	10	9	125	6	-10°	TB □ T0601 □ □	FTNA0204	TW06P	2

● Stock item, ○ Under preparing for stock

SWUBR/L

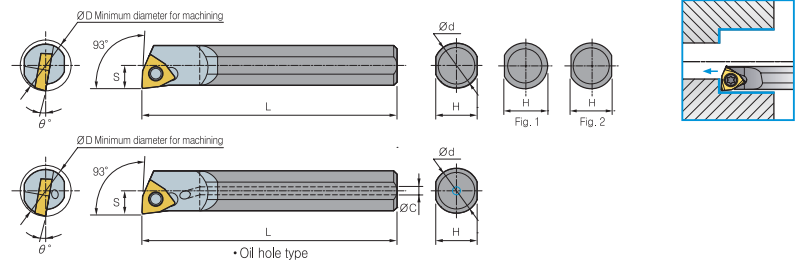

Desingation	Stock		ØD	Ød	H	L	S	θ°	Parts Insert	Screw	Wrench	Fig.
	R	L										
C05H-SWUBR/L-02	●	○	6	5	4.4	100	3	-15°	WB □ T0201 □ □	FTNA0203	TW06P	1
C06H-SWUBR/L-02	●	○	7	6	5.4	100	3.5	-15°	WB □ T0201 □ □	FTNA0203	TW06P	1
C08K-SWUBR/L-02	●	○	9	8	7	125	4.5	-12°	WB □ T0201 □ □	FTNA02033	TW06P	2
C08K-SWUBR/L-S3	●	○	10	8	7	125	5	-12°	WB □ TS302 □ □	FTNA02205	TW06P	2
E06H-SWUBR/L-02	●	○	7	6	5.4	100	3.5	-15°	WB □ T0201 □ □	FTNA0203	TW06P	1
E08K-SWUBR/L-02	●	○	9	8	7	125	4.5	-12°	WB □ T0201 □ □	FTNA02033	TW06P	2
E08K-SWUBR/L-S3	●	○	10	8	7	125	5	-12°	WB □ TS302 □ □	FTNA02205	TW06P	2

●: Stock item, ○: Under preparing for stock

Carbide Shank Boring Bars

SL(SLEEVE)



SL(SLEEVE)

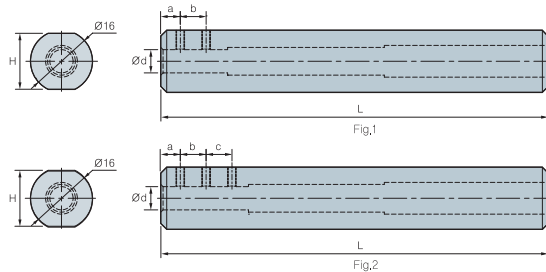

Desingation	Stock	ød	a	b	c	H	L	Screw	Wrench	Fig.
SL-1604	●	4	5	6	-	14	100	M4	HW20L	1
SL-1605	●	5	5	8	-	14	100	M4	HW20L	1
SL-1606	●	6	5	6	6	14	100	M4	HW20L	2
SL-1607	●	7	5	6	8	14	100	M4	HW20L	2

●: Stock item, ○: Under preparing for stock



Warning

※ Safety instruction

- Use glasses safely and face cover with protective equipment. If cutting condition and use method are inaccurate, you may be injured by broken tools or scattered chips.
- Excessive cutting load may influence badly on both tool and machine. Make suitable tool replacement for preventing failure of machining.
- After machine stopped, clean remained chips from machine with special cleaning equipment.
- Keep safety distance from acute and hot chip during machining.
- Make precaution for prevention of fire in advance when you use insoluble cutting oil.
- Assembled parts may be scattered at high speed cutting. Please use protective equipment.